



Copa de Espana Absoluta Madrid 2017

Madrid (MAD), 16 Dec 2017

-60 kg
15 Judoka

POOL A

1	SAIZ JUAN, Ian	MAD	1	SAIZ JUAN, Ian
17				17
9			2	
25				25
5			3	MRABET TORRES, Ismael
21	MRABET TORRES, Ismael	MAD		18
13	CARRANZA MORENO, Jose Man	MAD	4	CARRANZA MORENO, Jose Manuel
29				29

POOL A Winner / Ganador
Vainqueur / Sieger

POOL B

3	RODRIGUEZ ROJAS, Yasmani	VAS	5	RODRIGUEZ ROJAS, Yasmani
19				19
11	FARES, Mohamed Ayman	MAD	6	FARES, Mohamed Ayman
27				27
7	GALAN BARBOSA, Jorge	MAD	7	GALAN BARBOSA, Jorge
23				23
15	JIMENEZ ALFONSO, Gabriel	MUR	8	JIMENEZ ALFONSO, Gabriel
31				31

POOL B Winner / Ganador
Vainqueur / Sieger

POOL C

2	LOPEZ MENDEZ, Ruben	MAD	9	LOPEZ MENDEZ, Ruben
18				18
10			10	
26				26
6	NUNEZ RODRIGUEZ, Justo Aleja	MAD	11	
22	OLMOS AMONDARAIN, Josu	VAS		22
14	SANCHEZ-ORO EXTREMERA, Di	MAD	12	SANCHEZ-ORO EXTREMERA, Diego
30				30

POOL C Winner / Ganador
Vainqueur / Sieger

POOL D

4	MAYA TOVAR, Ignacio	CAT	13	MAYA TOVAR, Ignacio
20				20
12			14	
28				28
8	BLAZQUEZ FERNANDEZ, Diego	MAD	15	
24	GARCIA AGUDO, Alvaro	MAD		24
16	SENRA BALESTRA, Noel	MAD	16	SENRA BALESTRA, Noel
32				32

POOL D Winner / Ganador
Vainqueur / Sieger

Trostrunde / Repechage / Ronda de consolación

Repechage

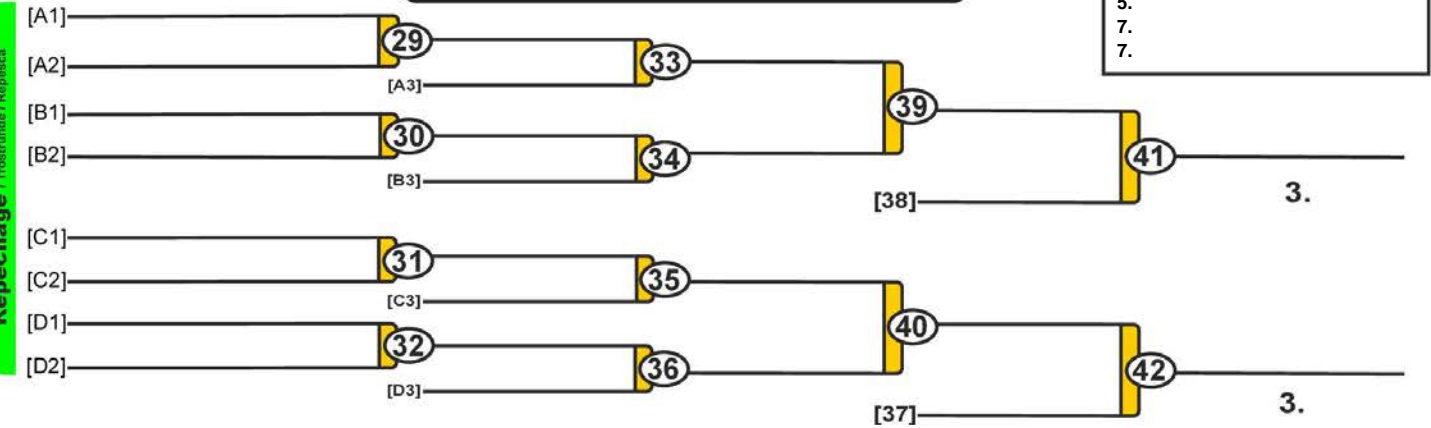

Results	
Résultat / Platzierungen / Resultados	
1.	
2.	
3.	
3.	
5.	
5.	
7.	
7.	



Copa de Espana Absoluta Madrid 2017

Madrid (MAD), 16 Dec 2017

-66 kg

19 Judoka

POOL A

1	CARRANZA MORENO, Alberto	MAD	1	CARRANZA MORENO, Alberto
17				17
9			2	
25				25
5	DOMINGUEZ RUBIO, Francisco	MAD	3	
21	SIMO PAYERAS, Jaume	BAL		18
13	MORALES, Jose Manuel	AND	4	
29	SEGADO FERNANDEZ, Daniel	MAD		29

POOL A Winner / Ganador
Vainqueur / Sieger

POOL B

3	ARAGONES LOZANO, Samuel	MAD	5	ARAGONES LOZANO, Samuel
19				19
11			6	
27				27
7	CASAS FERNANDEZ, Ricardo	EXT	7	
23	CHACON BEJAR, Moises	AND		20
15	CHINCHILLA IGLESIAS, Daniel	MAD	8	
31	ZAPATA MARIN, Antonio	MUR		31

POOL B Winner / Ganador
Vainqueur / Sieger

POOL C

2	SAMPAN, Vasyl	CAT	9	SAMPAN, Vasyl
18				21
10			10	
26				26
6	DIAZ GONZALEZ, Amador	MAD	11	
22	MONTERO GONZALEZ, Mario	MAD		22
14	JORGE DIAS, Oscar	MAD	12	JORGE DIAS, Oscar
30				30

POOL C Winner / Ganador
Vainqueur / Sieger

POOL D

4	ALBITOS LOPEZ, Ivan	MAD	13	ALBITOS LOPEZ, Ivan
20				23
12			14	
28				28
8	GARCIA, Ricardo	AST	15	
24	ALZAS HERNANDEZ, Julen	VAS		24
16	LOBO PALOMO, Javier	MAD	16	
32	BRETONES GARCIA, Jose Migue	AND		32

POOL D Winner / Ganador
Vainqueur / Sieger

Trostrunde / Repechage / Ronda de consolación

Repechage / Trostrunde / Repecha

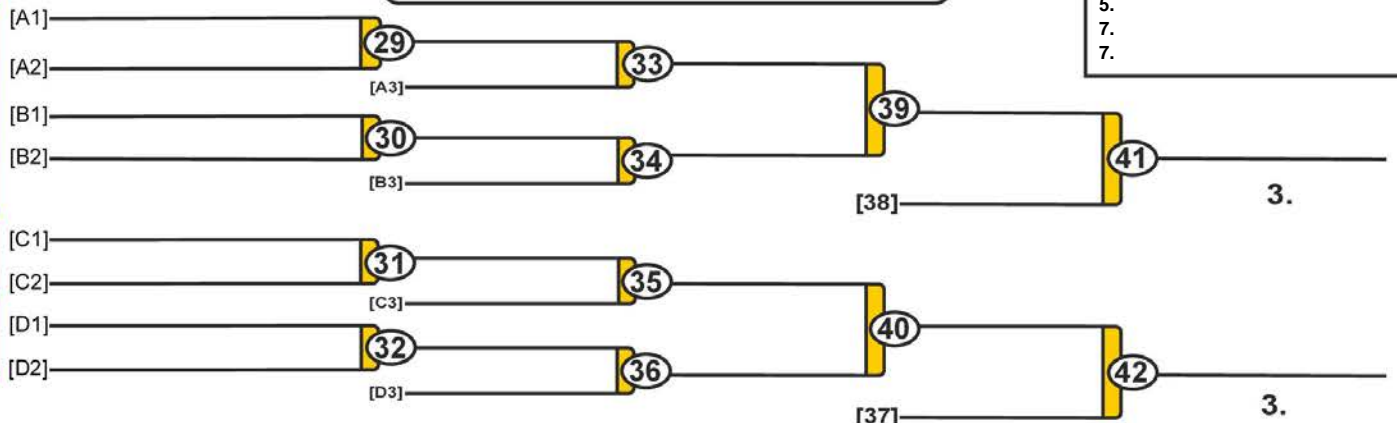

Results	
Resultat / Platzierungen / Resultados	
1.	
2.	
3.	
3.	
5.	
5.	
7.	
7.	



Copa de Espana Absoluta Madrid 2017

Madrid (MAD), 16 Dec 2017

-73 kg

28 Judoka

POOL A

1	XARGAY, Eduard	CAT	1	XARGAY, Eduard
33			33	
17			2	
49			2	
9	MORENO HONTANILLA, Miguel Angel	MAD	3	MORENO HONTANILLA, Miguel Angel
41			3	
25	SIERRA ALMENARA, Daniel	ARA	4	
57	GONZALO LOPEZ SANCHEZ ROJAS, MAD		4	
5	FERNANDEZ MORENO, Daniel	MAD	5	FERNANDEZ MORENO, Daniel
37			5	
21			6	
53			6	
13	DIAZ MAIRENA, Daniel	MAD	7	DIAZ MAIRENA, Daniel
45			7	
29	SIERRA RODRIGUEZ, Antonio	MUR	8	SIERRA RODRIGUEZ, Antonio
61			8	

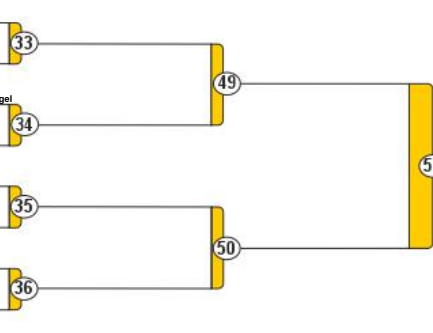

POOL A Winner / Ganador / Vainqueur / Sieger

POOL B

3	HERRANZ MORENO, Ignacio	MAD	9	HERRANZ MORENO, Ignacio
35			9	
19			10	
51			10	
11	DIAZ LORES, Armando	MAD	11	DIAZ LORES, Armando
43			11	
27	PICOT, Eole	FRA	12	PICOT, Eole
59			12	
7	SANCHEZ FERNANDEZ, Antonio Pedro	MAD	13	SANCHEZ FERNANDEZ, Antonio Pedro
39			13	
23			14	
55			14	
15	FERNANDEZ LABARRA, David	MAD	15	FERNANDEZ LABARRA, David
47			15	
31	DEL ROSAL PEDRAJAS, Francisco	AND	16	
63	PANADERO PARDO, Gabriel	MAD	16	

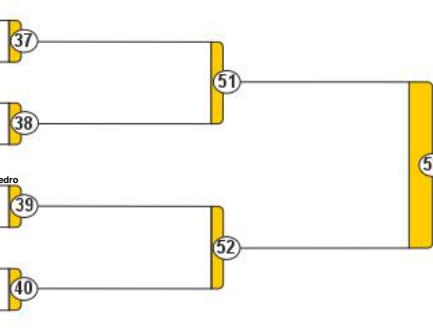

POOL B Winner / Ganador / Vainqueur / Sieger

POOL C

2	MASANES SEGARRA, Edgar	CAT	17	MASANES SEGARRA, Edgar
34			17	
18			18	
50			18	
10	AGUILAR VEGA, Carlos	MAD	19	AGUILAR VEGA, Carlos
42			19	
26	FERNANDEZ RODRIGUEZ, Fernando	MAD	20	FERNANDEZ RODRIGUEZ, Fernando
58			20	
6	CHAKVETADZE, Nika	CAT	21	CHAKVETADZE, Nika
38			21	
22			22	
54			22	
14	MORIANO DUCE, Samuel	MAD	23	MORIANO DUCE, Samuel
46			23	
30			24	
62	GALLEGO LAZARO, Javier	GAL	24	GALLEGO LAZARO, Javier

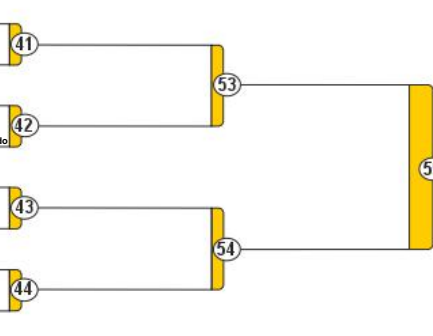

POOL C Winner / Ganador / Vainqueur / Sieger

POOL D

4	SOTILLO GOMEZ, Carlos	MAD	25	SOTILLO GOMEZ, Carlos
36			25	
20			26	
52			26	
12	SANCHEZ-ORO EXTREMERA, Daniel	MAD	27	SANCHEZ-ORO EXTREMERA, Daniel
44			27	
28	CAPARROS HITA, Yeray	MUR	28	
60	ROMAN MATIAS, Alain	VAS	28	
8	GONZALEZ HERRAEZ, Ruben	MAD	29	GONZALEZ HERRAEZ, Ruben
40			29	
24			30	
56			30	
16	CANO GARCIA, Jorge	MAD	31	CANO GARCIA, Jorge
48			31	
32	GARRIDO QUINTERO, Guillermo	MAD	32	
64	NUSSBAUMER, Leon	OTR	32	

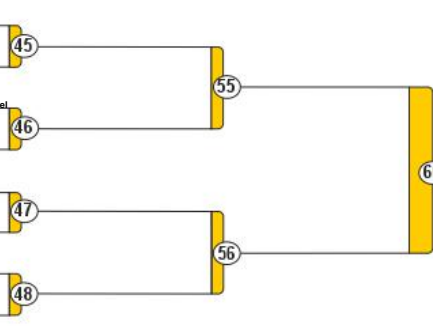

POOL D Winner / Ganador / Vainqueur / Sieger

1.

79

73

58

74

Results

Résultat / Platzierungen / Resultados

- 1.
- 2.
- 3.
- 5.
- 5.
- 7.
- 7.

Trostrunde / Repechage / Ronda de consolação

Repechage

[A1]				
[A2]				
[B1]				
[B2]				
[C1]				
[C2]				
[D1]				
[D2]				

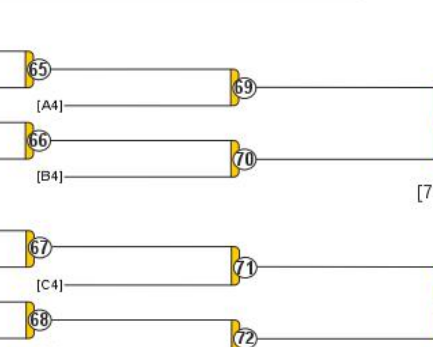

[73]

3.

3



Copa de Espana Absoluta Madrid 2017

Madrid (MAD), 16 Dec 2017

-81 kg

20 Judoka

POOL A

1	CAMINERO SASTRE, Alvaro	MAD
33		
17		
49		
9		
41		
25		
57		
5	MOLINA GENER, William	MAD
37	MARTINEZ SALVADOR, Esteban	VAS
21	SANCHEZ SANCHEZ, David	MAD
53		
13	PEREZ RUIZ, Cesar	AND
45		
29		
61		

1	CAMINERO SASTRE, Alvaro	33
2		49
3		34
4		
5		35
6	SANCHEZ SANCHEZ, David	50
7	PEREZ RUIZ, Cesar	36
8		

POOL A Winner / Ganador
Vainqueur / Sieger

POOL B

3	MORO RUANO, Sergio	MAD
35		
19		
51		
11		
43		
27		
59		
7	ORTEGA CIDONCHA, Jesus	EXT
39		
23	SECEAC, Bogdan Leon	ARA
55		
15		
47		
31	RUF VILLANUEVA, Pablo	MAD
63		

9	MORO RUANO, Sergio	37
10		51
11		38
12		
13	ORTEGA CIDONCHA, Jesus	39
14	SECEAC, Bogdan Leon	52
15		40
16	RUF VILLANUEVA, Pablo	

POOL B Winner / Ganador
Vainqueur / Sieger

POOL C

2	ROMERA GASPARICO, Jose Luis	AND
34		
18		
50		
10		
42		
26		
58		
6	IGLESIAS GARCIA, Edgar	CAT
38	GONZALEZ SORIA, Jorge	MAD
22	RODRIGUEZ BAIRERA, Jorge	MAD
54		
14	RUF VILLANUEVA, Alvaro	MAD
46		
30	ADURIZ CARDONA, Gorka	VAS
62		

17	ROMERA GASPARICO, Jose Luis	41
18		53
19		42
20		
21		43
22	RODRIGUEZ BAIRERA, Jorge	54
23	RUF VILLANUEVA, Alvaro	44
24	ADURIZ CARDONA, Gorka	

POOL C Winner / Ganador
Vainqueur / Sieger

POOL D

4	BUENDIA LABELLA, Pablo	AND
36		
20		
52		
12		
44		
28	RUPERTO PIEDRABUENA, Paco	MAD
60		
8	GARCIA ITURBIDE, Jose Antonio	MAD
40		
24	CALVO PINAR, Jose Miguel	MAD
56		
16		
48		
32	CAMPOS MUNOZ, Miguel	MAD
64		

25	BUENDIA LABELLA, Pablo	45
26		55
27		46
28	RUPERTO PIEDRABUENA, Paco	47
29	GARCIA ITURBIDE, Jose Antonio	47
30	CALVO PINAR, Jose Miguel	56
31		48
32	CAMPOS MUNOZ, Miguel	

POOL D Winner / Ganador
Vainqueur / Sieger

1.

3.

3

Trostrunde / Repechage / Ronda de consolación

Repechage

[A1]	
[A2]	61
[B1]	
[B2]	62
[C1]	
[C2]	63
[D1]	
[D2]	64

[A3]		65
[A4]		69
[B3]		66
[B4]		70
[C3]		67
[C4]		71
[D3]		68
[D4]		72

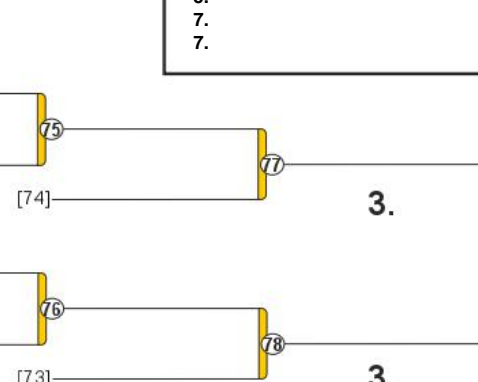

Results

Résultat / Platzierungen / Resultados

- 1.
- 2.
- 3.
- 5.
- 5.
- 7.
- 7.



Copa de Espana Absoluta Madrid 2017

Madrid (MAD), 16 Dec 2017

-90 kg

13 Judoka

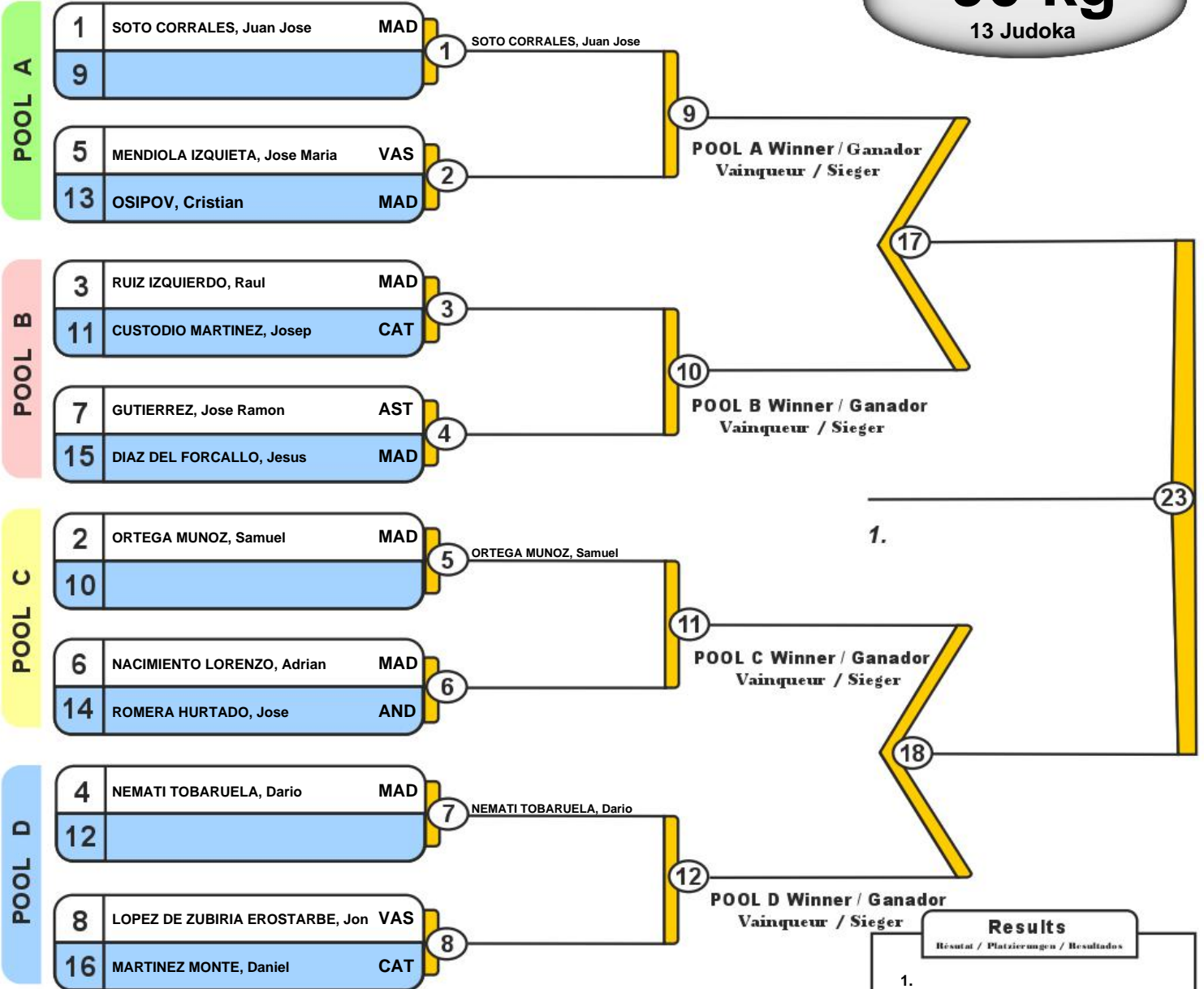

Trostrunde / Repechage / Ronda de consolación

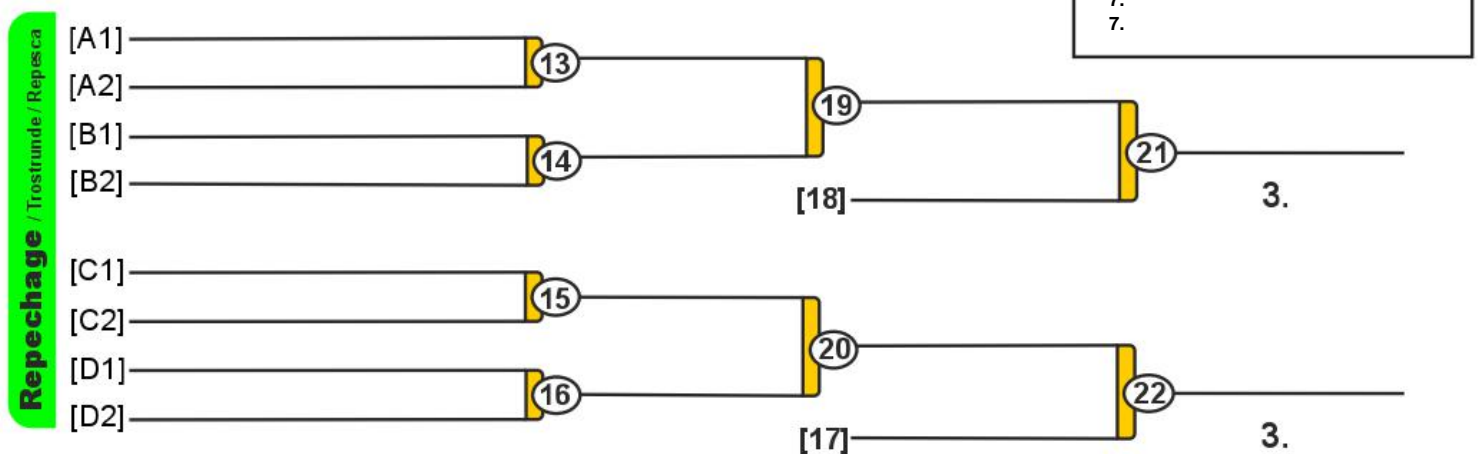

Results	
Resultat / Platzierungen / Resultados	
1.	
2.	
3.	
3.	
5.	
7.	
7.	



www.allforcombat.es



Copa de Espana Absoluta Madrid 2017

Madrid (MAD), 16 Dec 2017

-100 kg

17 Judoka

POOL A

1	PLESCA, Petru	CAT	1	PLESCA, Petru
17				17
9			2	
25				
5	HERNANDEZ RODRIGUEZ, Dieg	MAD	3	
21	CAZORLA VICENTE, Peio	VAS		18
13	RINCON GONZALEZ, Roman	MAD	4	RINCON GONZALEZ, Roman
29				

POOL A Winner / Ganador
Vainqueur / Sieger

POOL B

3	YOUNG HASSAN, Saleh	CAT	5	YOUNG HASSAN, Saleh
19				19
11			6	
27				
7	ZHANG, Zhaogi	MAD	7	ZHANG, Zhaogi
23				20
15	LOZANO HERRERA, Julian	MAD	8	
31	SORIANO LAGUNA, Ismael	MAD		

POOL B Winner / Ganador
Vainqueur / Sieger

POOL C

2	GOMEZ RODRIGUEZ, Carlos Antonio	MAD	9	GOMEZ RODRIGUEZ, Carlos Antonio
18				21
10			10	
26				
6	BARRY VAN BECK, Illoy	BAL	11	
22	GARCIA PEREZ, Alejandro	GAL		22
14	GONZALEZ NAVARRO, Pedro Pa	AND	12	
30	PORRAS DIEGUEZ, Jesus	MAD		

POOL C Winner / Ganador
Vainqueur / Sieger

POOL D

4	SAGASTI CONDE, Asier	VAS	13	SAGASTI CONDE, Asier
20				23
12			14	
28				
8	GARCIA GARCIA, Pedro Amalio	MAD	15	GARCIA GARCIA, Pedro Amalio
24				24
16	POURZAND, Dario	MAD	16	
32	SAEZ PASCUAL, Victor Javier	MAD		

POOL D Winner / Ganador
Vainqueur / Sieger

Trostrunde / Repechage / Ronda de consolación

Repechage



Results	
Resultat / Platzierungen / Resultados	
1.	
2.	
3.	
3.	
5.	
5.	
7.	
7.	



Copa de Espana Absoluta Madrid 2017

Madrid (MAD), 16 Dec 2017

+100 kg

6 Judoka

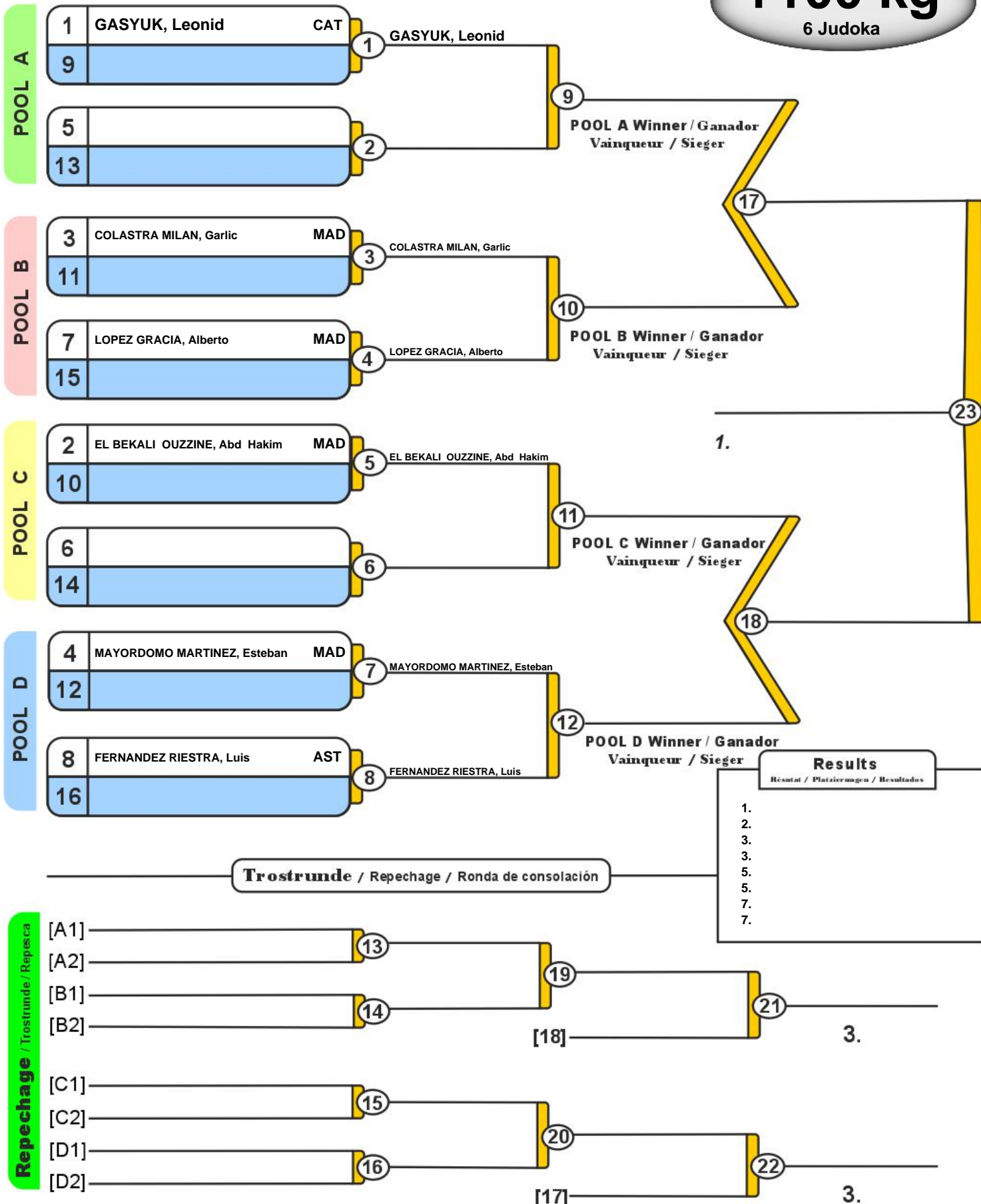



Copa de Espana Absoluta Madrid 2017

Madrid (MAD), 16 Dec 2017

-48 kg

6 Judoka

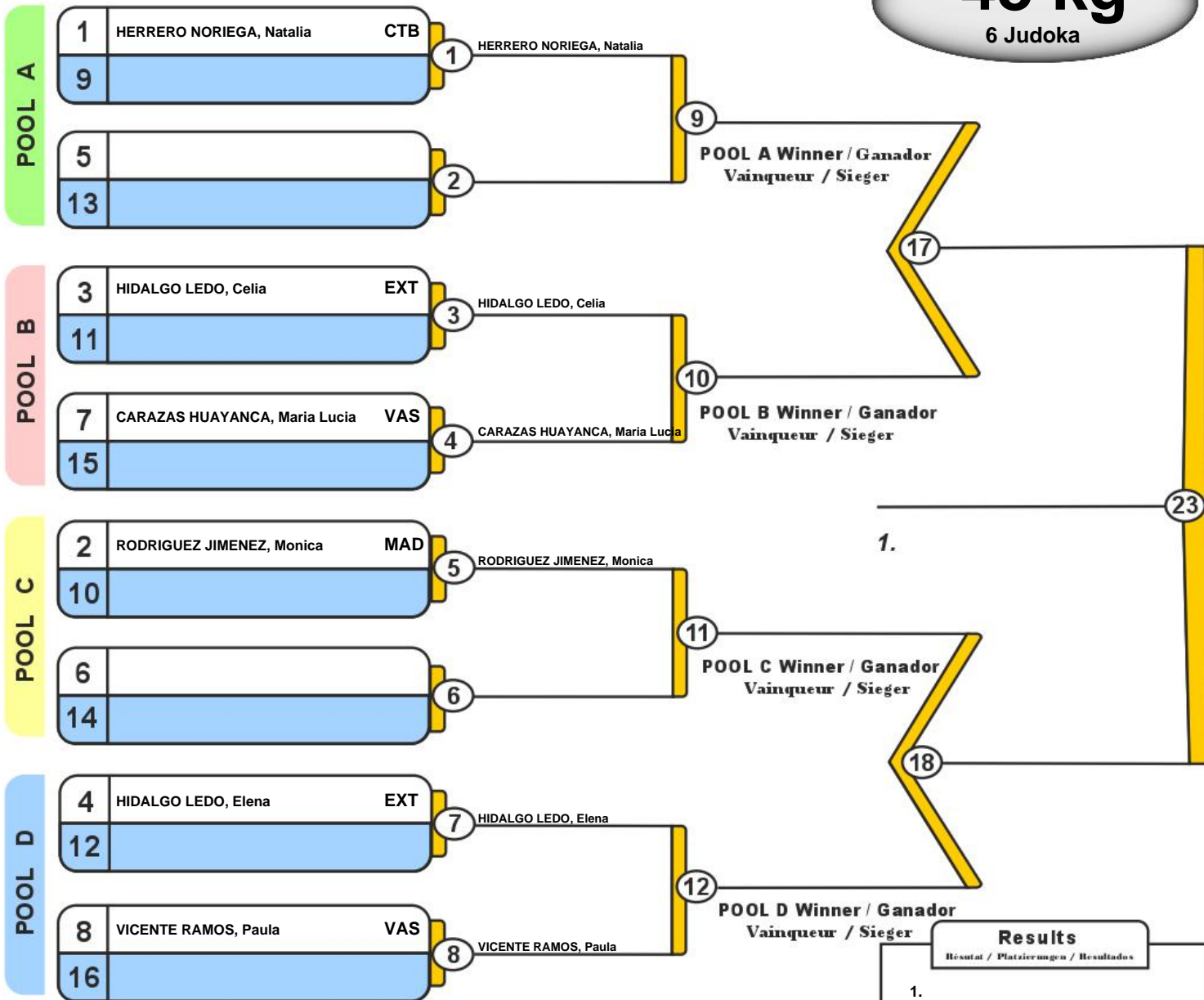

Trostrunde / Repechage / Ronda de consolación

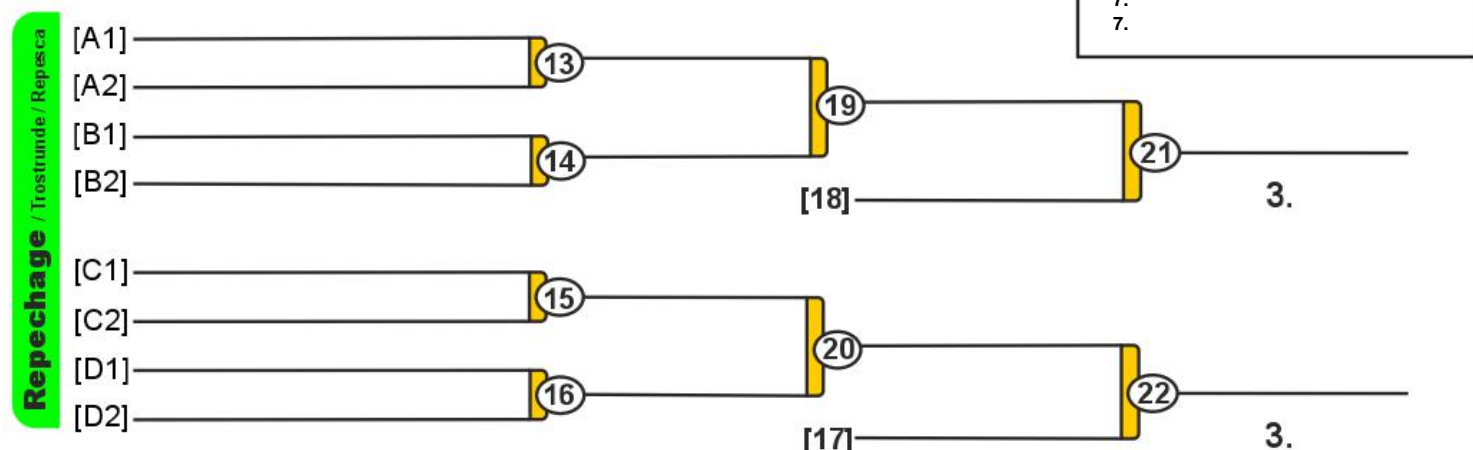

www.allforcombat.es



Copa de Espana Absoluta Madrid 2017

Madrid (MAD), 16 Dec 2017

-52 kg

16 Judoka

POOL A

1	MUNOZ OREJUELA, Sheyla	MAD
17		
9		
25		
5	LEON FERNANDEZ, Joana	MAD
21	LANZA CHACORIS, Paula	MAD
13	FERRERAS DE PALMA, Elena	MAD
29	MARTINEZ DE LUCO USATEGI, Naira	MAD

1	MUNOZ OREJUELA, Sheyla
2	
3	
4	
5	
6	
7	
8	
9	
10	
11	
12	
13	
14	
15	
16	
17	
18	
19	
20	
21	
22	
23	
24	
25	
26	
27	
28	
29	
30	
31	
32	
33	
34	
35	
36	
37	
38	
39	
40	
41	
42	
43	

POOL B

3	DE LA CRUZ ALZAGA, Sandra	CLE
19		
11		
27		
7	MORENO MUNOZ, Esther	MAD
23		
15		
31	GUTIERREZ RIOJA, Alba	MAD

5	DE LA CRUZ ALZAGA, Sandra
6	
7	MORENO MUNOZ, Esther
8	GUTIERREZ RIOJA, Alba

POOL C

2	LOPEZ-VENTURA MARTINEZ, Virginia	MAD
18		
10		
26		
6	RODRIGUEZ RODRIGUEZ, Cristina	CLE
22	BALLESTEROS GONZALEZ, Izaskun	MAD
14		
30	PEREZ DIAZ, Naira	MAD

9	LOPEZ-VENTURA MARTINEZ, Virginia
10	
11	
12	PEREZ DIAZ, Naira

POOL D

4	CONFORTI RAINERI, Anna	EXT
20		
12		
28		
8	RIOS ZENTENO, Ghislaine Macanilla	MAD
24	DIAZ VIDAL, Irene	MUR
16		
32	CHINCHILLA IGLESIAS, Lucia	MAD

13	CONFORTI RAINERI, Anna
14	
15	
16	CHINCHILLA IGLESIAS, Lucia

Trostrunde / Repechage / Ronda de consolación

Repechage / Trostrunde / Repecha

[A1]		29
[A2]		
[B1]		30
[B2]		
[C1]		31
[C2]		
[D1]		32
[D2]		

[A3]		33
[B3]		34
[C3]		35
[D3]		36

Results	
Resultado / Platzierungen / Resultados	
1.	
2.	
3.	
3.	
5.	
5.	
7.	
7.	



Copa de Espana Absoluta Madrid 2017

Madrid (MAD), 16 Dec 2017

-57 kg

8 Judoka

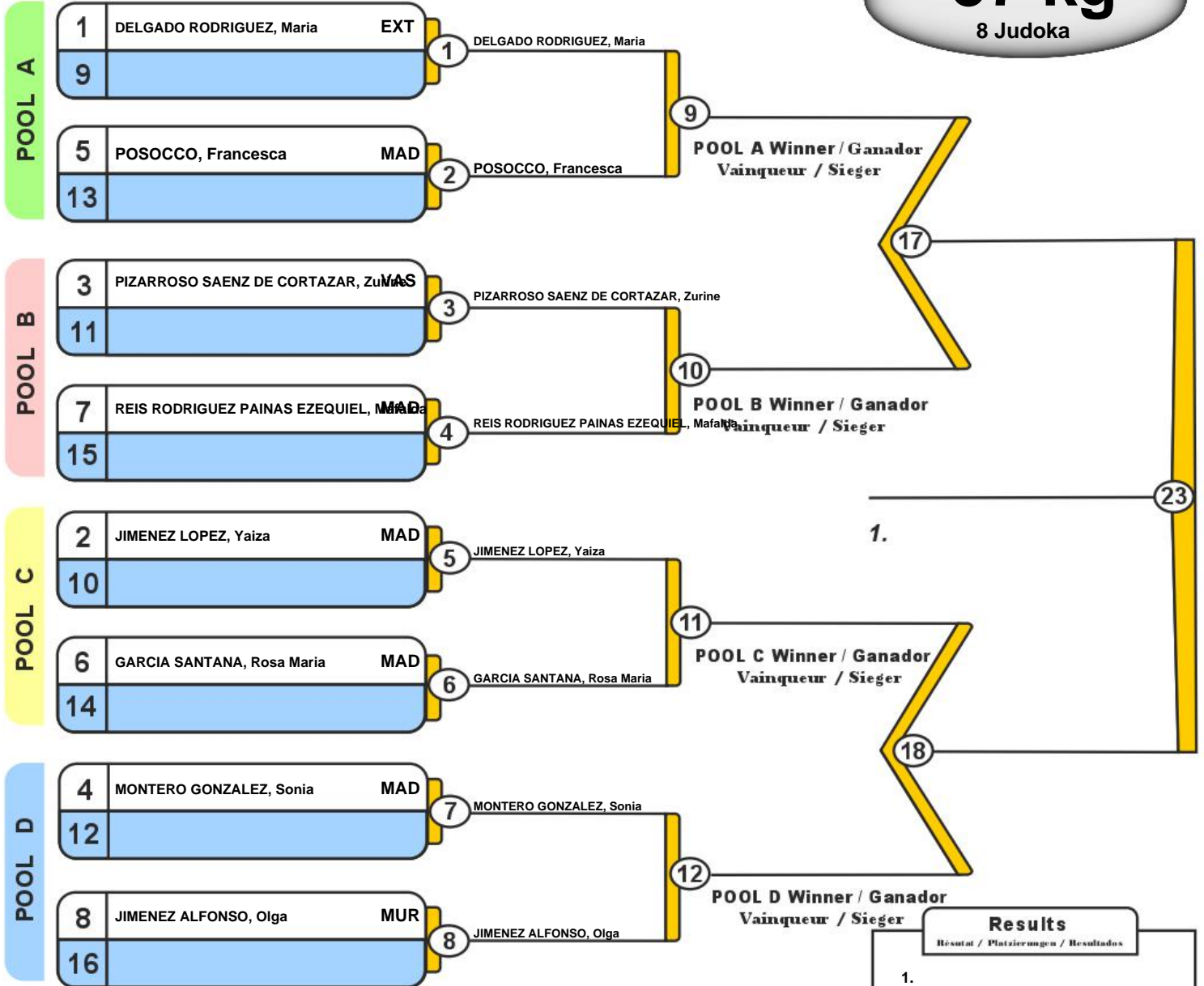

1.

POOL C Winner / Ganador
Vainqueur / Sieger

POOL D Winner / Ganador
Vainqueur / Sieger

Results

Resultat / Platzierungen / Resultados

- 1.
- 2.
- 3.
- 3.
- 5.
- 7.
- 7.

Trostrunde / Repechage / Ronda de consolación

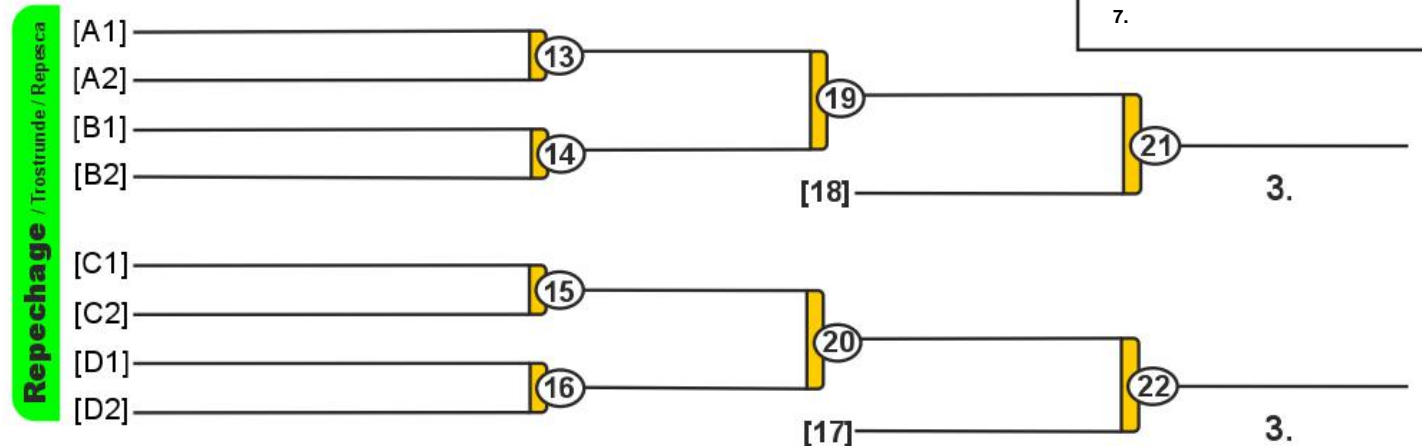

3.

3.



www.allforcombat.es



Copa de Espana Absoluta Madrid 2017

Madrid (MAD), 16 Dec 2017

-63 kg

8 Judoka

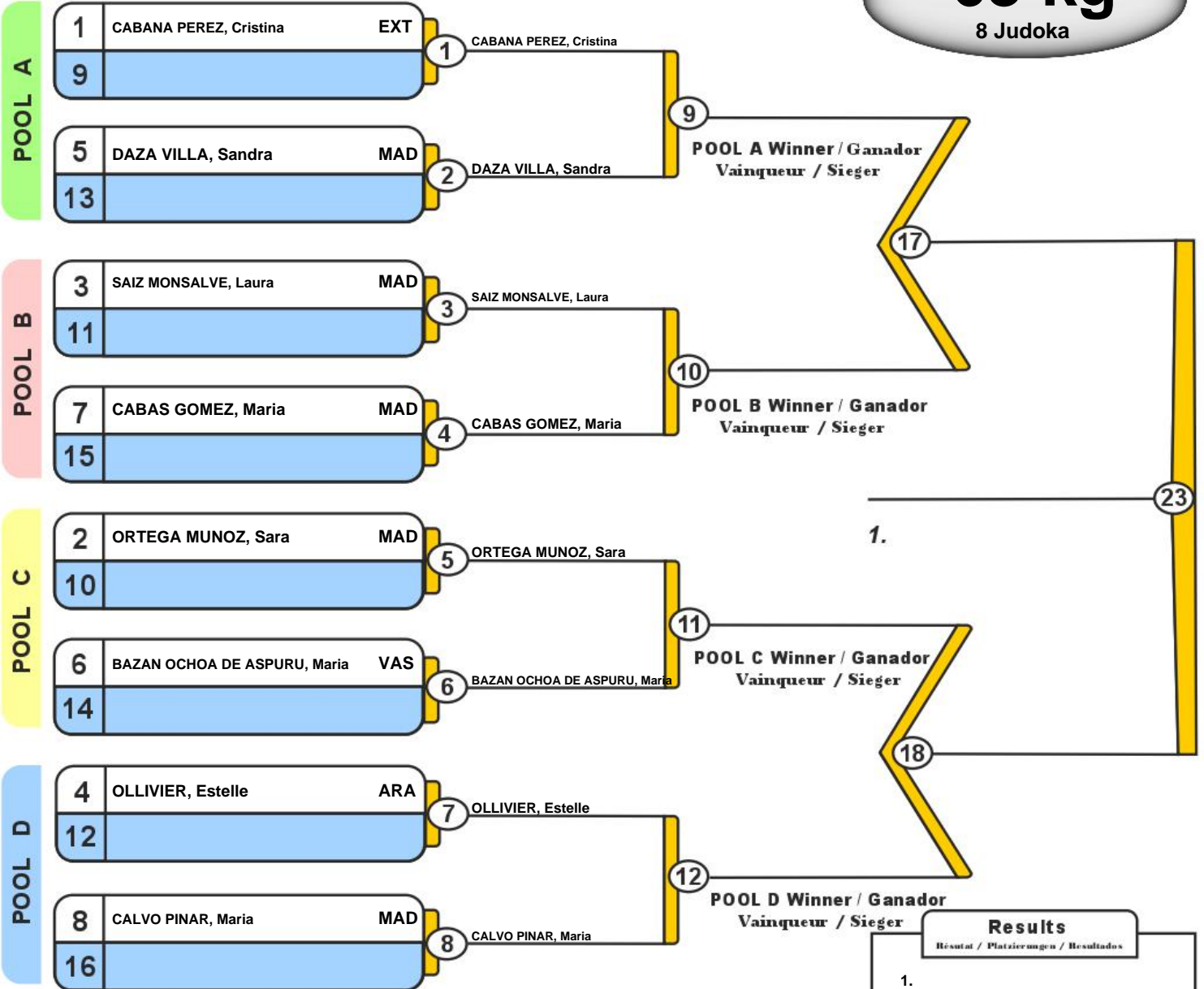

1.

POOL C Winner / Ganador
Vainqueur / Sieger

POOL D Winner / Ganador
Vainqueur / Sieger

Trostrunde / Repechage / Ronda de consolación

Results	
Resultat / Platzierungen / Resultados	
1.	
2.	
3.	
3.	
5.	
7.	
7.	

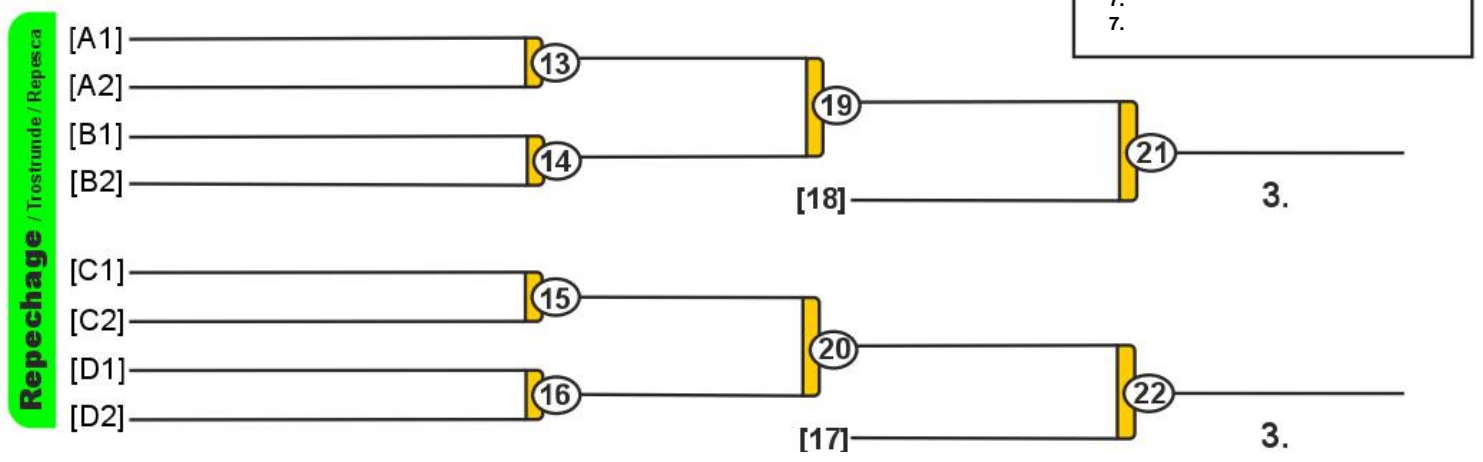

www.allforcombat.es



Copa de Espana Absoluta Madrid 2017

Madrid (MAD), 16 Dec 2017

-70 kg

7 Judoka

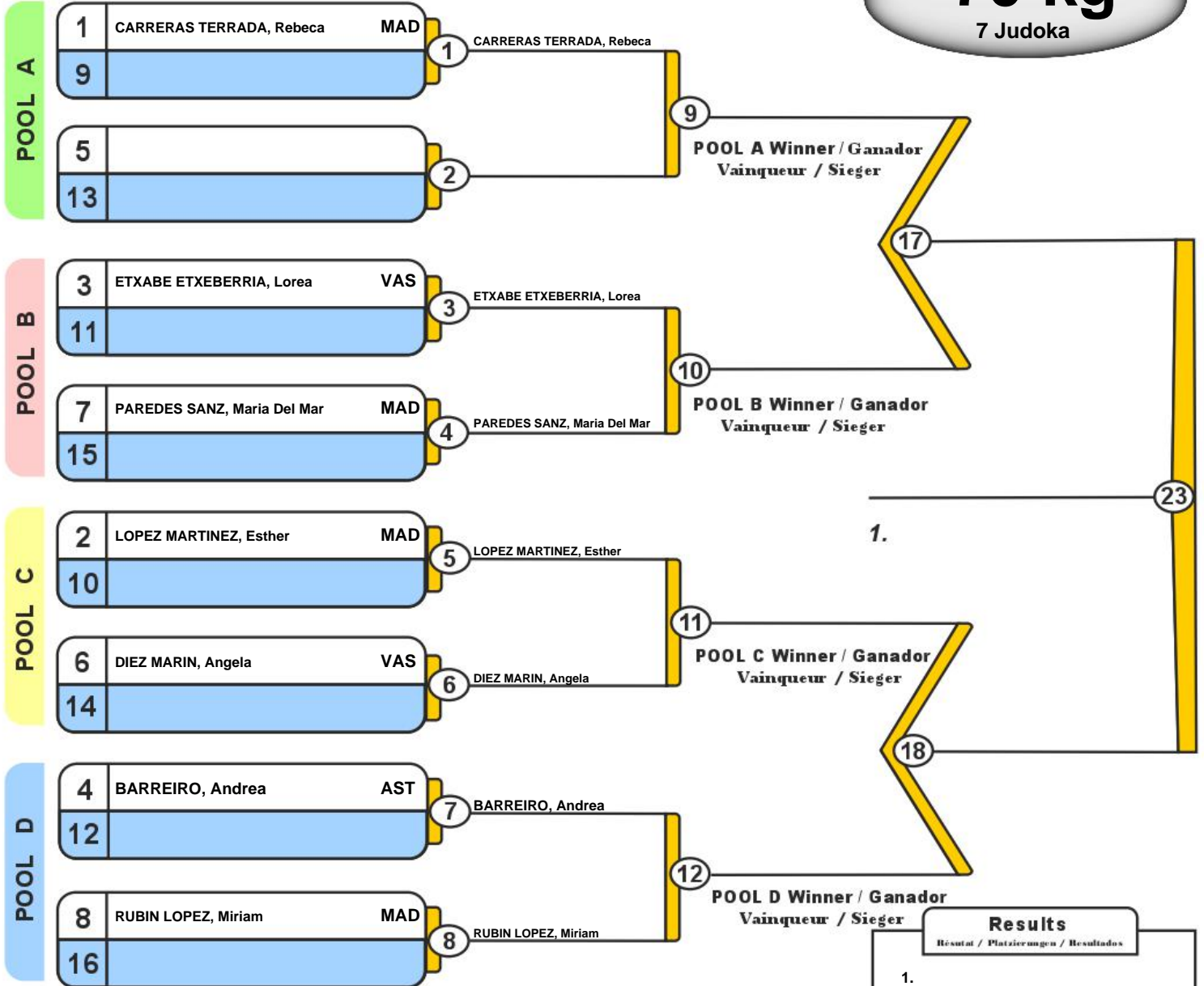

1.

POOL C Winner / Ganador
Vainqueur / Sieger

POOL D Winner / Ganador
Vainqueur / Sieger

Results

Resultat / Platzierungen / Resultados

- 1.
- 2.
- 3.
- 3.
- 5.
- 7.
- 7.

Trostrunde / Repechage / Ronda de consolación

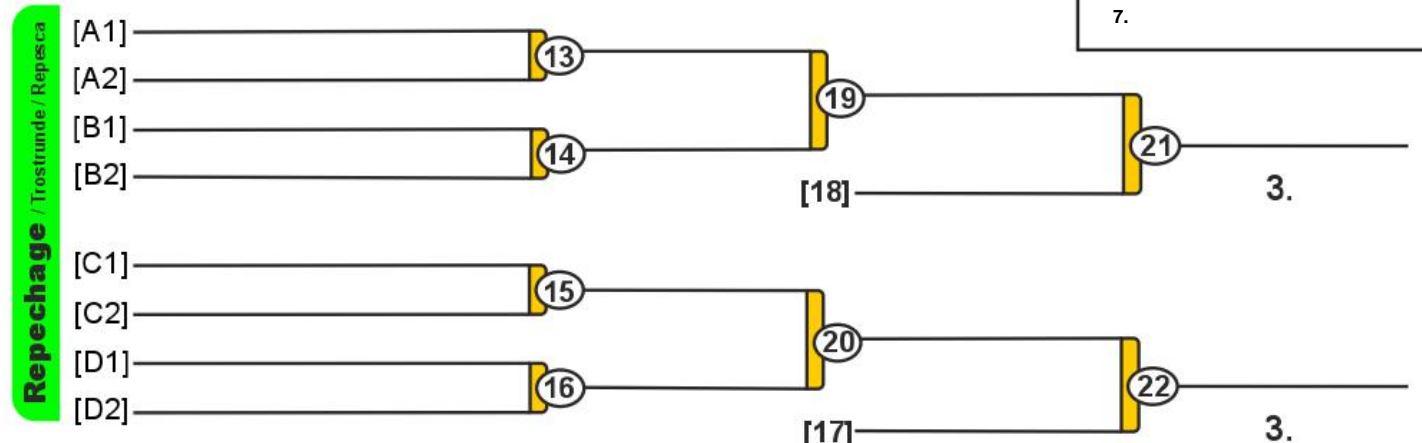

		1	2	3	4	
1	RODRIGUEZ GONZALEZ, Patricia MAD					0 (0)
2	GARCIA AGUILAR, Silvia MAD					0 (0)
3	BRAVO SARABIA, Candela MAD					0 (0)
4	YARZA OLASO, Lidia VAS					0 (0)

1 RODRIGUEZ GONZALEZ, Patricia MAD 1 _____

2 GARCIA AGUILAR, Silvia MAD _____

3 BRAVO SARABIA, Candela MAD 2 _____

4 YARZA OLASO, Lidia VAS _____

1 RODRIGUEZ GONZALEZ, Patricia MAD 3 _____

3 BRAVO SARABIA, Candela MAD _____

2 GARCIA AGUILAR, Silvia MAD 4 _____

4 YARZA OLASO, Lidia VAS _____

1 RODRIGUEZ GONZALEZ, Patricia MAD 5 _____

4 YARZA OLASO, Lidia VAS _____

2 GARCIA AGUILAR, Silvia MAD 6 _____

3 BRAVO SARABIA, Candela MAD _____

Final Results

1. _____
2. _____
3. _____



Copa de Espana Absoluta Madrid 2017

Madrid (MAD), 16 Dec 2017

+78 kg

4 Judoka

			1	2	3	4	
1	FERRER BARTULOS, Patricia	ARA					0 (0)
2	PERRET MADELEINE, Aurelie	VAS					0 (0)
3	LIMA BORDOLI, Iara Lucia	MAD					0 (0)
4	BOUSBA, Nisrin	MAD					0 (0)

1	FERRER BARTULOS, Patricia	ARA	①	_____
2	PERRET MADELEINE, Aurelie	VAS		

3	LIMA BORDOLI, Iara Lucia	MAD	②	_____
4	BOUSBA, Nisrin	MAD		

1	FERRER BARTULOS, Patricia	ARA	③	_____
3	LIMA BORDOLI, Iara Lucia	MAD		

2	PERRET MADELEINE, Aurelie	VAS	④	_____
4	BOUSBA, Nisrin	MAD		

1	FERRER BARTULOS, Patricia	ARA	⑤	_____
4	BOUSBA, Nisrin	MAD		

2	PERRET MADELEINE, Aurelie	VAS	⑥	_____
3	LIMA BORDOLI, Iara Lucia	MAD		

Final Results

- 1.
- 2.
- 3.